

PRA Series

Spatter-resistance type proximity sensor

■ Features

- Improved the noise resistance with dedicated IC (DC 3-wire)
- Reverse power polarity (DC 3-wire), surge (DC/AC), overcurrent protection (DC type)
- Red LED status indication
- IP67 rated waterproof structure (IEC standard)
- Replacer for spatter-resistance type limit switch



⚠ Please read "Caution for your safety" in operation manual before using.



■ The characteristic of spatter-resistance type

The hot arc from arc welding machine is adhesive even with metals or plastics. Therefore, normal proximity sensor might have malfunction even though there are no sensing object if the arcs are put on the sensing surface. The arcs are not adhered on the sensing part of the spatter-resistance type proximity sensor as the part is coated with teflon against thermal resistance. Also, the protection cover sold optionally has the same function.

■ Specifications

● DC 2-wire type

Model	PRAT12-2DO	PRAWT12-2DO	PRAT18-5DO	PRAWT18-5DO	PRAT30-10DO	PRAWT30-10DO
	PRAT12-2DC	PRAWT12-2DC	PRAT18-5DC	PRAWT18-5DC	PRAT30-10DC	PRAWT30-10DC
Sensing distance	2mm ±10%		5mm ±10%		10mm ±10%	
Hysteresis	Max. 10% of sensing distance					
Standard sensing target	12×12×1mm (Iron)		18×18×1mm (Iron)		30×30×1mm (Iron)	
Setting distance	0 ~ 1.4mm		0 ~ 3.5mm		0 ~ 7mm	
Power supply (Operating voltage)	24VDC (15-30VDC)					
Leakage current	Max. 0.6mA					
Response frequency(*1)	1.5kHz		500Hz		400Hz	
Residual voltage	Max. 3.5V					
Affection by Temp.	±10% Max. for sensing distance at +20°C within temperature range of -25 ~ +70°C					
Control output	2 ~ 100mA					
Insulation resistance	Min. 50MΩ (at 500VDC mega)					
Dielectric strength	1500VAC 50/60Hz for 1 minute					
Vibration	1mm amplitude at frequency of 10 ~ 55Hz in each of X, Y, Z directions for 2 hours					
Shock	500m/s ² (50G) in X, Y, Z direction for 3 times					
Indicator	Operating indicator (Red LED)					
Ambient temperature	-25 ~ +70°C (at non-freezing status)					
Storage temperature	-30 ~ +80°C (at non-freezing status)					
Ambient humidity	35 ~ 95%RH					
Protection circuit	Surge, Overcurrent protection circuit					
Protection	IP67 (IEC standard)					
Cable	φ4×2P, 2m			φ5×2P, 2m		
Approval	CE					
Unit weight	Approx. 63g	Approx. 45g	Approx. 122g	Approx. 65g	Approx. 181g	Approx. 130g

*(*1) The response frequency is the average value. The standard sensing target is used and the width is set as 2 times of the standard sensing target, 1/2 of the sensing distance for the distance.

*IEC standard item is available and add "-I" to the end of model. Ex) PRAWT12-2DO-I

*See J-48 for IEC standard connector cables and specifications.

Cylindrical Spatter-Resistance Type

■ Specifications

● DC 3-wire type

Model	PRA12-2DN PRA12-2DP PRA12-2DN2 PRA12-2DP2	PRA18-5DN PRA18-5DP PRA18-5DN2 PRA18-5DP2	PRA30-10DN PRA30-10DP PRA30-10DN2 PRA30-10DP2
Sensing distance	2mm ±10%	5mm ±10%	10mm ±10%
Hysteresis	Max. 10% of sensing distance		
Standard sensing target	12×12×1mm (Iron)	18×18×1mm (Iron)	30×30×1mm (Iron)
Setting distance	0 ~ 1.4mm	0 ~ 3.5mm	0 ~ 7mm
Power supply (Operating voltage)	12-24VDC (10-30VDC)		
Current consumption	Max. 10mA		
Response frequency(*1)	1.5kHz	500Hz	400Hz
Residual voltage	Max. 1.5V		
Affection by Temp.	±10% Max. for sensing distance at +20°C within temperature range of -25 ~ +70°C		
Control output	Max. 200mA		
Insulation resistance	Min. 50MΩ (at 500VDC mega)		
Dielectric strength	1500VAC 50/60Hz for 1 minute		
Vibration	1mm amplitude at frequency of 10 ~ 55Hz in each of X, Y, Z directions for 2 hours		
Shock	500m/s ² (50G) in X, Y, Z direction for 3 times		
Indicator	Operation indicator (Red LED)		
Ambient temperature	-25 ~ +70°C (at non-freezing status)		
Storage temperature	-30 ~ +80°C (at non-freezing status)		
Ambient humidity	35 ~ 95%RH		
Protection circuit	Reverse polarity protection, Surge protection circuit, Overload & short circuit protection		
Protection	IP67 (IEC standard)		
Cable	φ 4×3P, 2m	φ 5×3P, 2m	
Approval	CE		
Unit weight	Approx. 70g	Approx. 119g	Approx. 184g

*(*1) The response frequency is the average value. The standard sensing target is used and the width is set as 2 times of the standard sensing target, 1/2 of the sensing distance for the distance.

● AC 2-wire type

Model	PRA12-2AO PRA12-2AC	PRA18-5AO PRA18-5AC	PRA30-10AO PRA30-10AC
Sensing distance	2mm ±10%	5mm ±10%	10mm ±10%
Hysteresis	Max. 10% of sensing distance		
Standard sensing target	12×12×1mm (Iron)	18×18×1mm (Iron)	30×30×1mm (Iron)
Setting distance	0 ~ 1.4mm	0 ~ 3.5mm	0 ~ 7mm
Power supply (Operating voltage)	100-240VAC (85-264VAC)		
Leakage current	Max. 2.5mA		
Response frequency(*1)	20Hz		
Residual voltage	Max. 10V		
Affection by Temp.	±10% Max. for sensing distance at +20°C within temperature range of -25 ~ +70°C		
Control output	5 ~ 150mA	5 ~ 200mA	
Insulation resistance	Min. 50MΩ (at 500VDC mega)		
Dielectric strength	2500VAC 50/60Hz for 1 minute		
Vibration	1mm amplitude at frequency of 10 ~ 55Hz in each of X, Y, Z directions for 2 hours		
Shock	500m/s ² (50G) in X, Y, Z direction for 3 times		
Indicator	Operation indicator (Red LED)		
Ambient temperature	-25 ~ +70°C (at non-freezing status)		
Storage temperature	-30 ~ +80°C (at non-freezing status)		
Ambient humidity	35 ~ 95%RH		
Protection circuit	Surge protection circuit		
Protection	IP67 (IEC standard)		
Cable	φ 4×2P, 2m	φ 5×2P, 2m	
Approval	CE		
Unit weight	Approx. 66g	Approx. 130g	Approx. 185g

*(*1) The response frequency is the average value. The standard sensing target is used and the width is set as 2 times of the standard sensing target, 1/2 of the sensing distance for the distance.

(A)
Counter

(B)
Timer

(C)
Temp.
controller

(D)
Power
controller

(E)
Panel
meter

(F)
Tacho/
Speed/
Pulse
meter

(G)
Display
unit

(H)
Sensor
controller

(I)
Switching
power
supply

(J)
Proximity
sensor

(K)
Photo
electric
sensor

(L)
Pressure
sensor

(M)
Rotary
encoder

(N)
Stepping
motor &
Driver &
Controller

(O)
Graphic
panel

(P)
Production
stoppage
models &
replacement

PRA Series

Dimensions

(Unit:mm)

●PRA12-2D□ ●PRAT12-2D□ ●PRAWT12-2D□

●PRA12-2A□

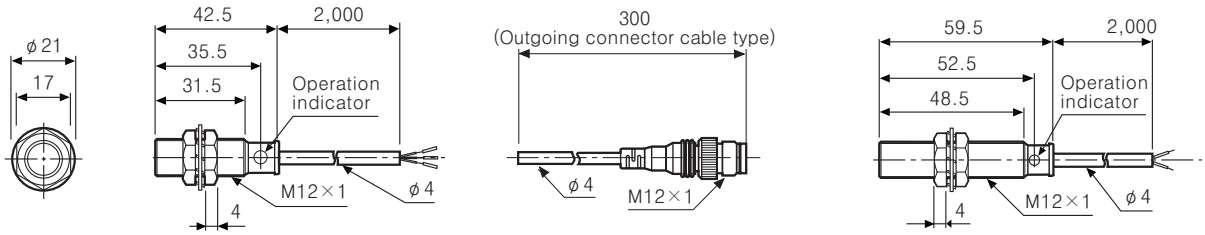

●PRA18-5D□ ●PRAT18-5D□ ●PRAWT18-5D□

●PRA18-5A□

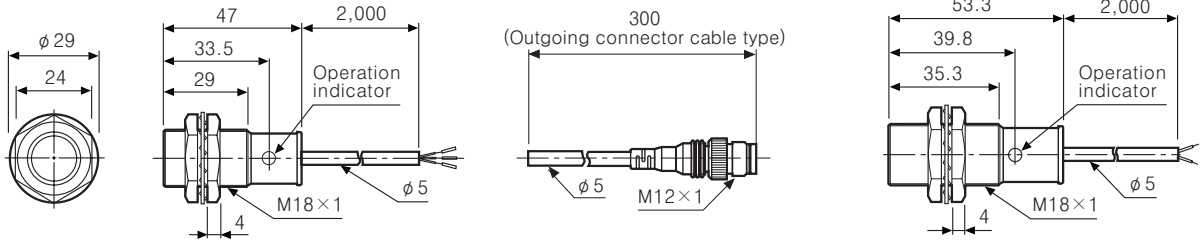

●PRA30-10D□ ●PRAT30-10D□ ●PRAWT30-10D□

●PRA30-10A□

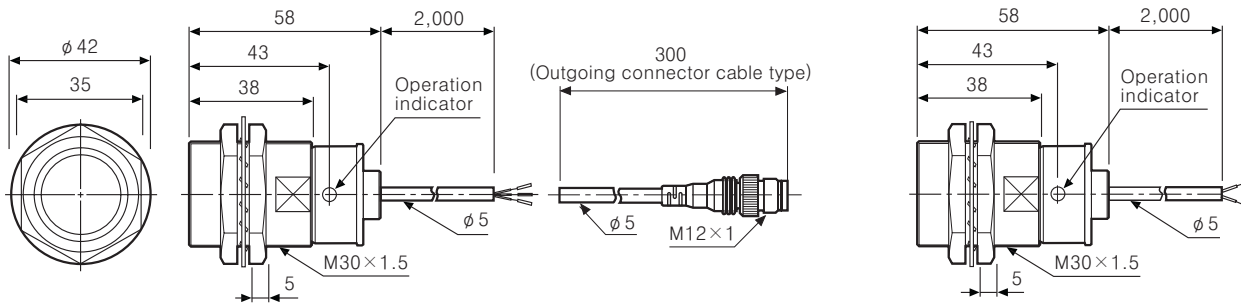

Control output diagram

◎DC 2-wire type

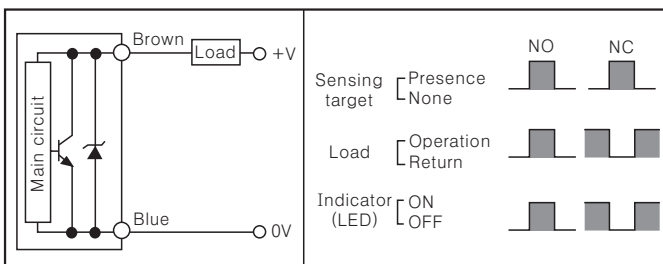

◎DC 3-wire type

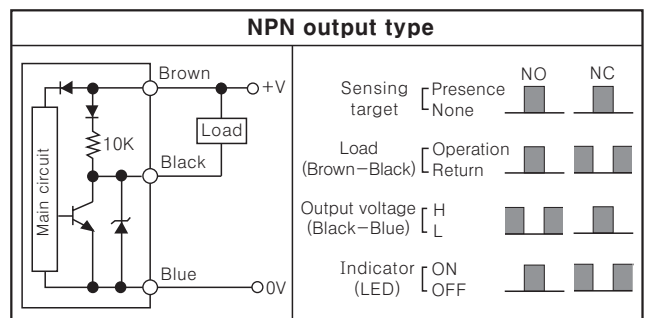

◎AC 2-wire type

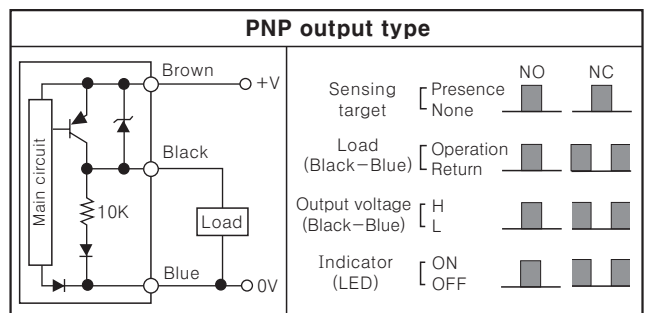
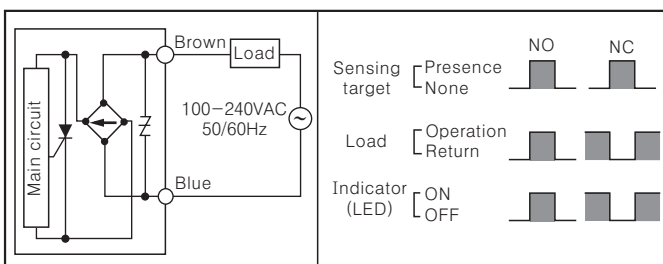

Cylindrical Spatter-Resistance Type

■ Connections

◎ DC 2-wire standard type / AC 2-wire type

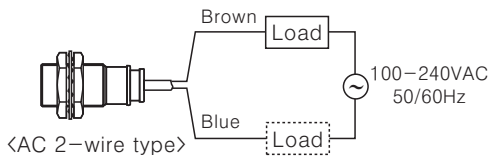
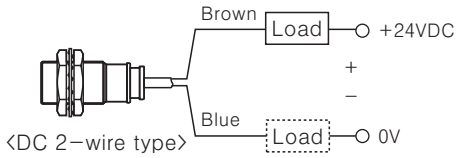

- ※ When using DC 2-wire and AC 2-wire type, a load must be connected before applying power; otherwise, components can be damaged.
- ※ The load can be connected to either wire.

◎ Connector

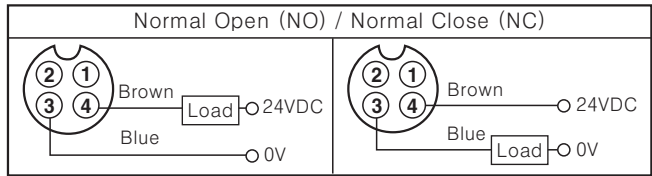

※ ①, ② are N · C (Not Connected) terminals.

◎ DC 2-wire type (IEC standard type)

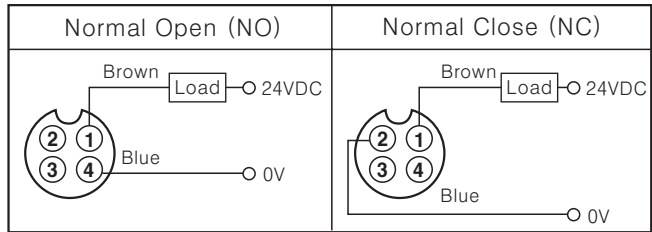

※ ②, ③ of NO Type and ③, ④ of NC Type are N · C (Not Connected) terminals.

■ Proper usage

◎ In case of the load current is small

● AC 2-wire type

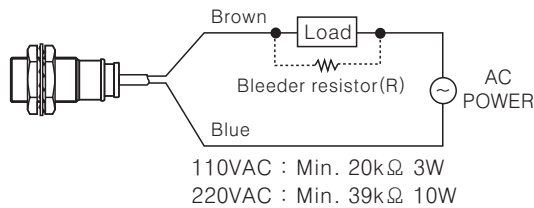

If the load current is under 5mA, please make sure the residual voltage is less than the return voltage of the load by connecting a bleeder resistor in parallel with the load as shown in the diagram.

$$R = \frac{V_s}{I} (\Omega) \quad P = \frac{V_s^2}{R} (W)$$

[I : Action current of load, R : Bleeder resistance, P : Permissible power]

● DC 2-wire type

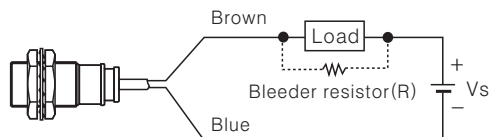

Please make the current on proximity sensor smaller than the return current of load by connecting a bleeder resistor in parallel.

※ W value of Bleeder resistor should be bigger for proper heat dissipation.

$$R = \frac{V_s}{I_o - I_{off}} (\Omega) \quad P = \frac{V_s^2}{R} (W)$$

[Vs : Power supply, Io : Min. action current of proximity sensor
Ioff : Return current of load, P : Number of Bleeder resistance watt]

◎ Mutual-interference & Influence by surrounding metals

When several proximity sensors are mounted closely, malfunction of sensor may be caused due to mutual interference. Therefore, be sure to provide a minimum distance between the two sensors, as below charts.

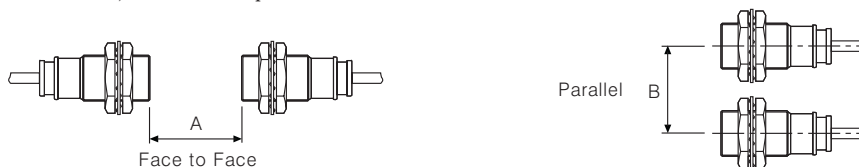

When sensors are mounted on metallic panel, you must prevent the sensors from being affected by any metallic object except target. Therefore, be sure to provide a minimum distance as below chart.

(Unit:mm)

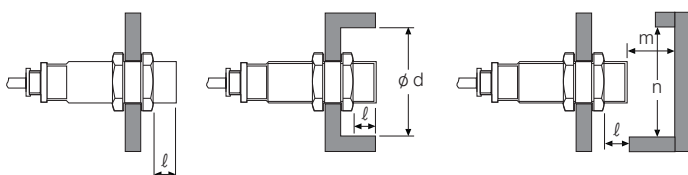

Model	PRA□12-2□□	PRA□18-5□□	PRA□30-10□□
Item			
A	12	30	60
B	24	36	60
l	0	0	0
φd	12	18	30
m	6	15	30
n	18	27	45

(A) Counter

(B) Timer

(C) Temp. controller

(D) Power controller

(E) Panel meter

(F) Tacho/Speed/Pulse meter

(G) Display unit

(H) Sensor controller

(I) Switching power supply

(J) Proximity sensor

(K) Photo electric sensor

(L) Pressure sensor

(M) Rotary encoder

(N) Stepping motor & Driver & Controller

(O) Graphic panel

(P) Production stoppage models & replacement